



Product  
Spec

# LED- illuminated sign letters

2020



**FIRE**BRAND

# Contents

## LaserLetter™

Face-lit	3
Halo-lit	4
Side-lit	5
Faux Neon	6

## TrueTrimless™

Face-lit	7
Halo-lit	8

## Brilliance™

9



John Bailey  
1.843.459.4239  
john@wearefirebrand.com  
[www.wearefirebrand.com](http://www.wearefirebrand.com)



# LaserLetter™

## Face-lit

- ❖ cast acrylic with embedded LEDs
- ❖ face-lit letter strokes as narrow as 2 mm
- ❖ low profile down to 25mm deep (just less than an inch)
- ❖ trim-less face, flush to returns
- ❖ painted returns and back
- ❖ paint color matching available

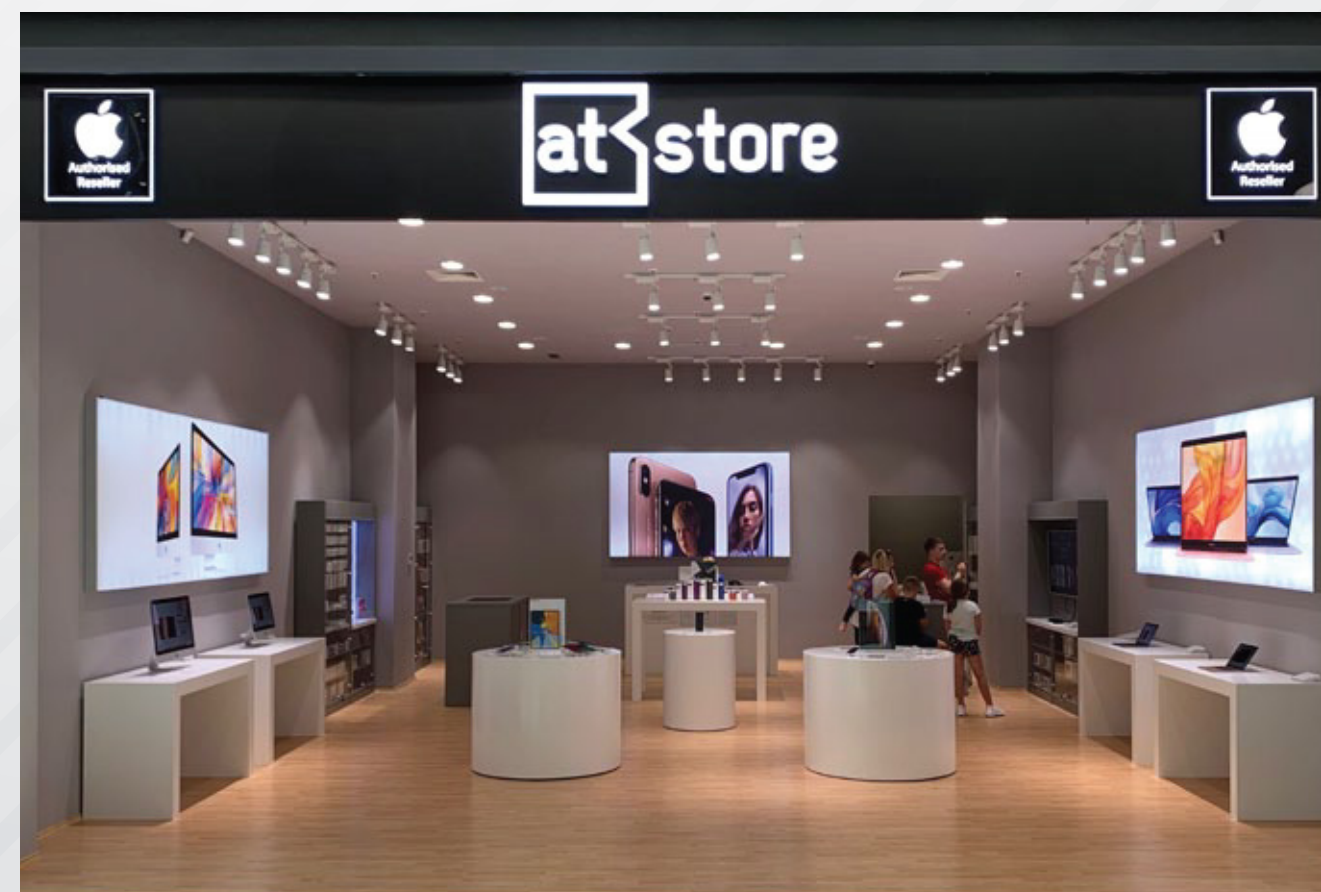
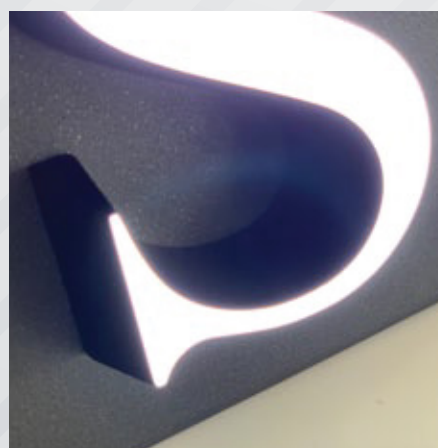
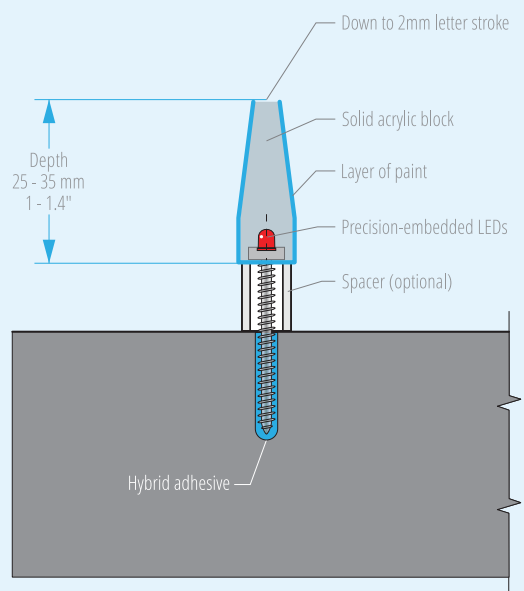
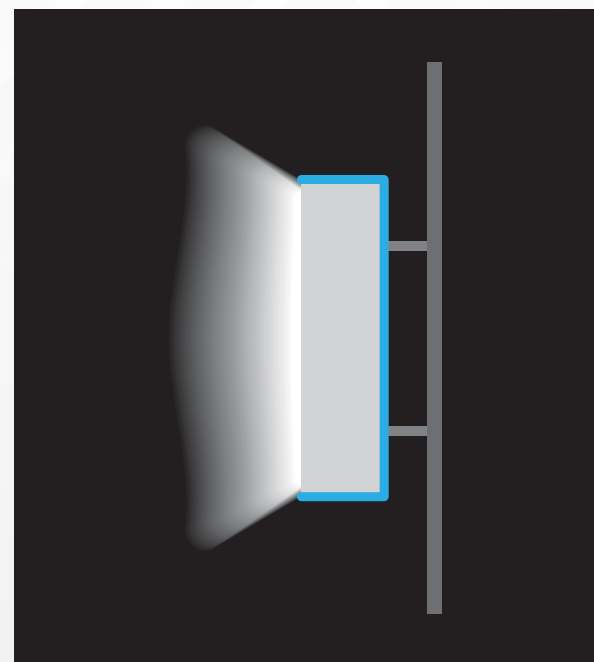
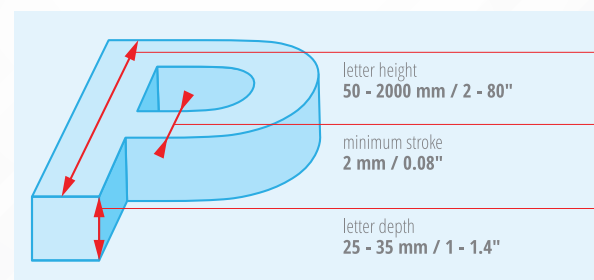
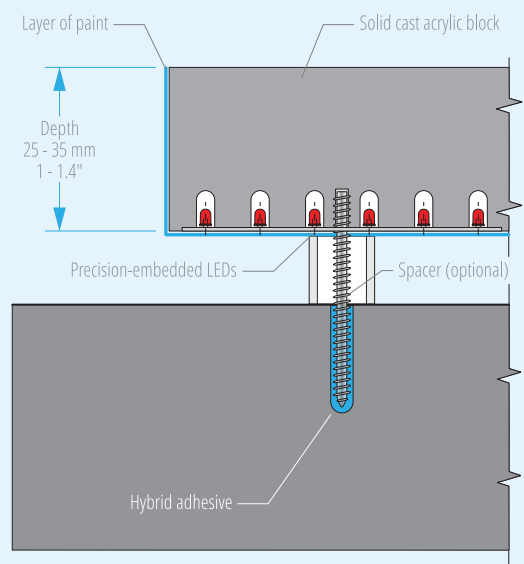

# LaserLetter™

## Halo-lit

- ❖ achieve a halo effect with flat cut-out cast acrylic that's a little more than 3/8" thick
- ❖ precision LED placement to maximize quality of halo diffusion
- ❖ painted face and returns
- ❖ paint color matching available

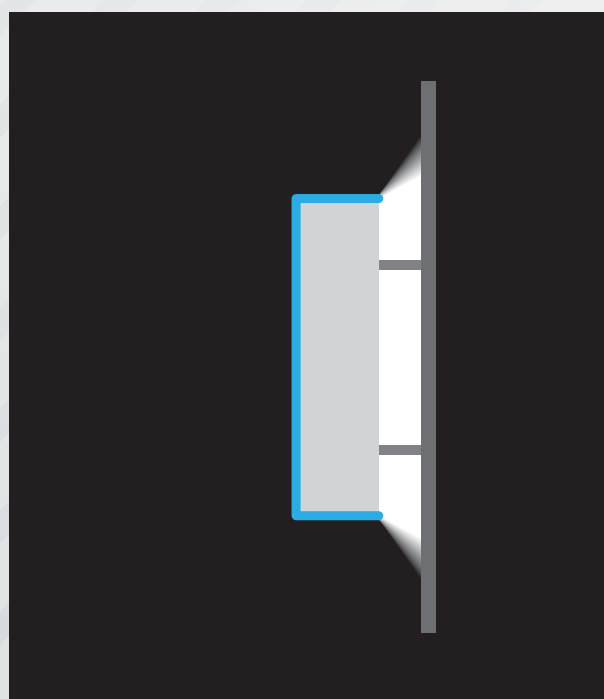
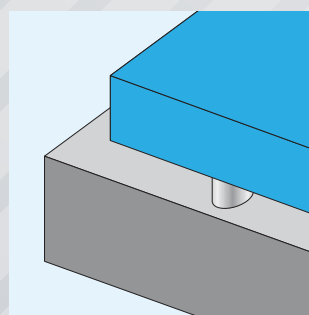
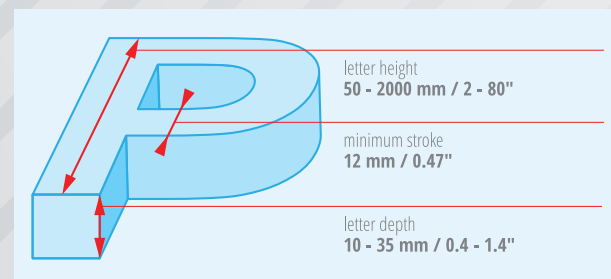
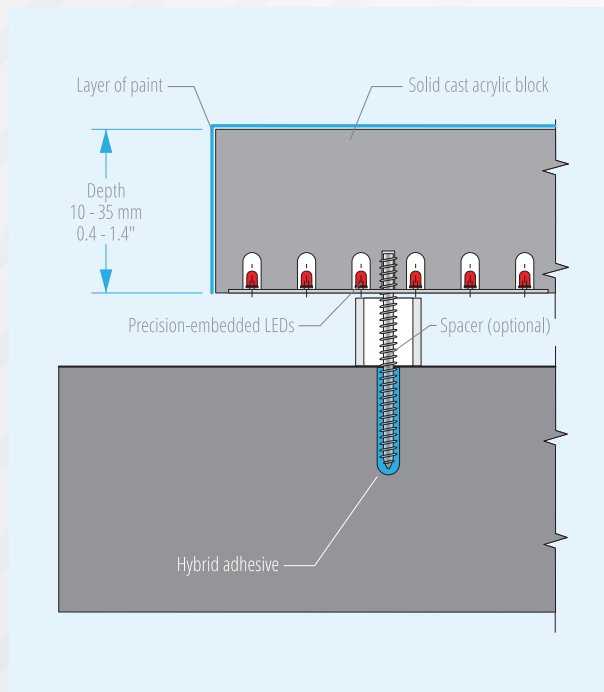

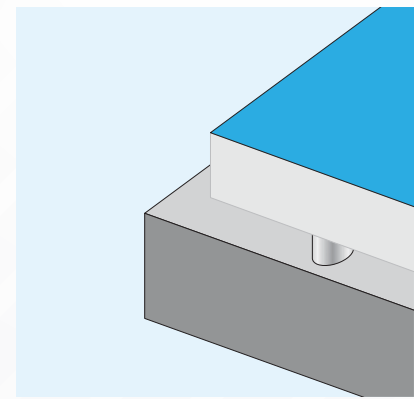

# LaserLetter™

## Side-lit

- ❖ solid cast acrylic block
- ❖ precision-embedded LEDs
- ❖ painted face and back
- ❖ paint color matching available

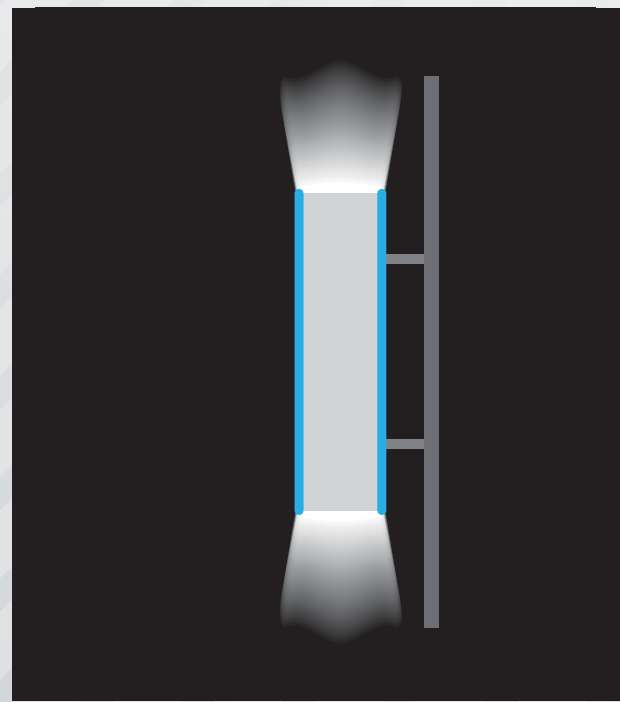
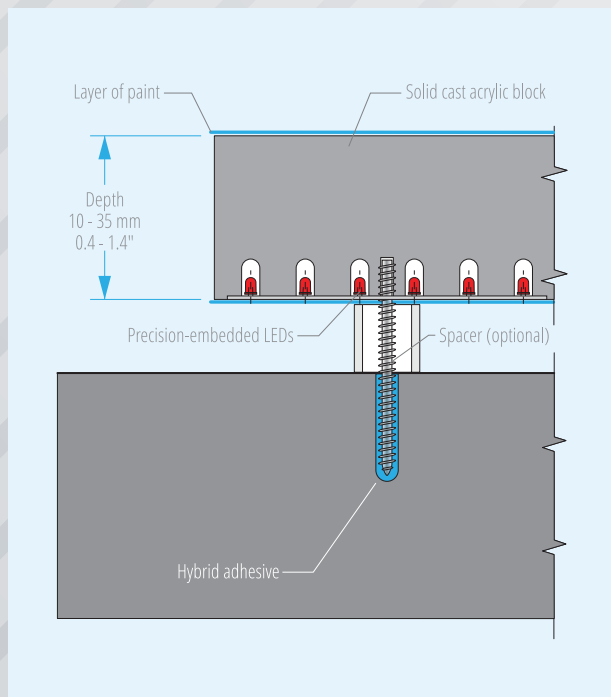
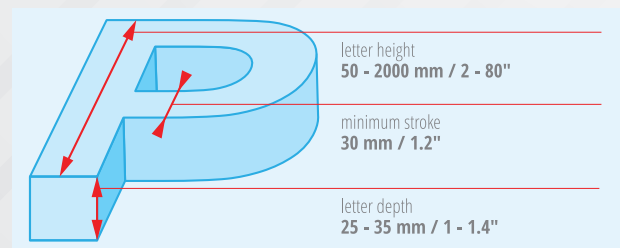

# LaserLetter™

## Faux Neon

- ◆ solid cast acrylic block
- ◆ precision-embedded LEDs
- ◆ face with tight curve
- ◆ option for curved returns
- ◆ paint color matching available

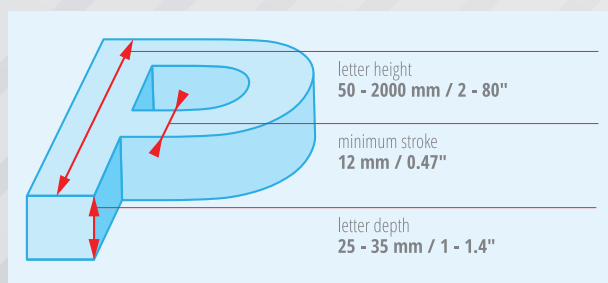
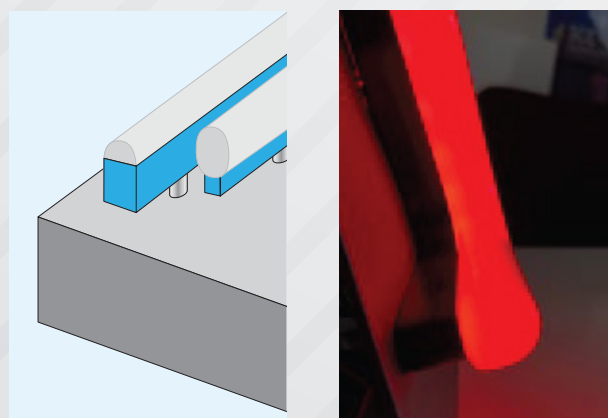
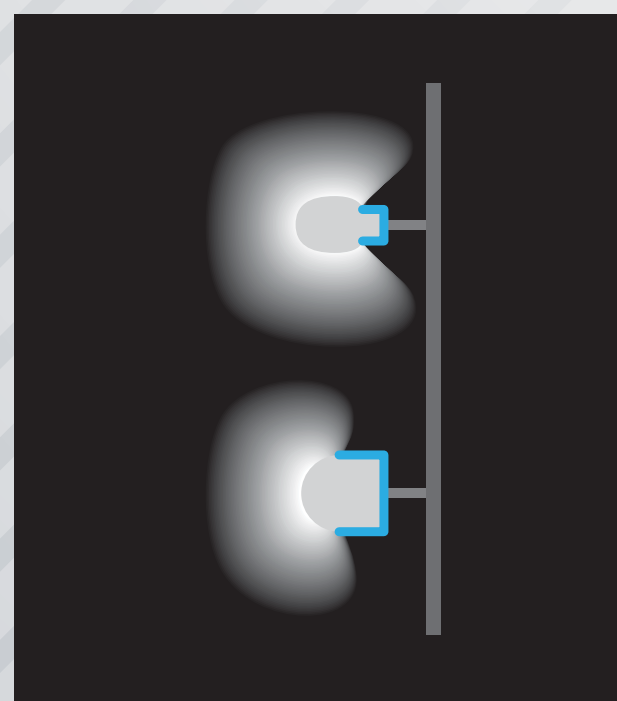
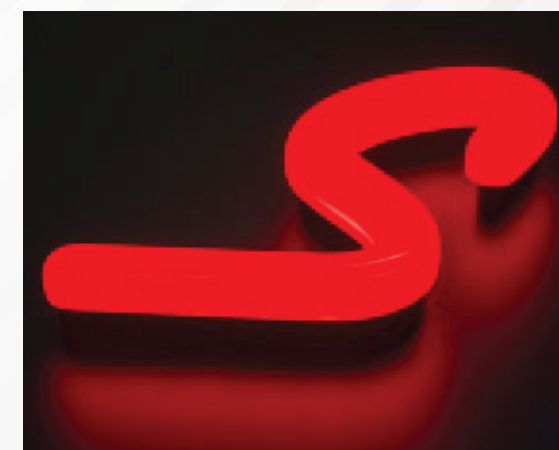
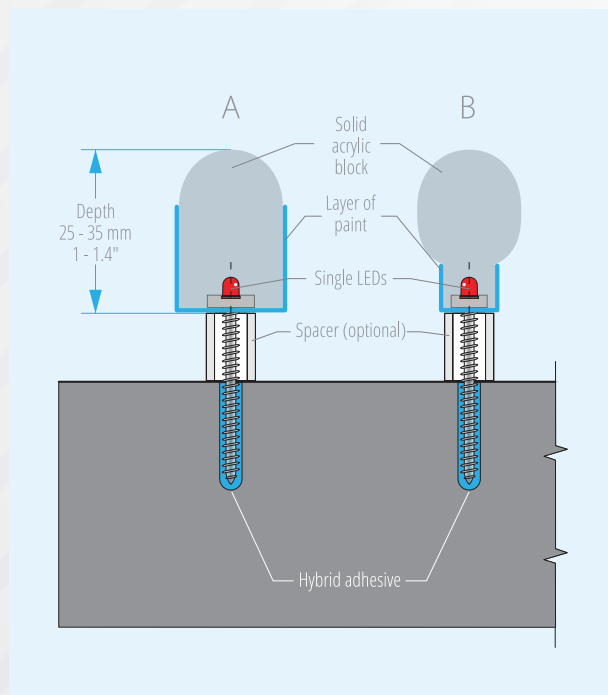

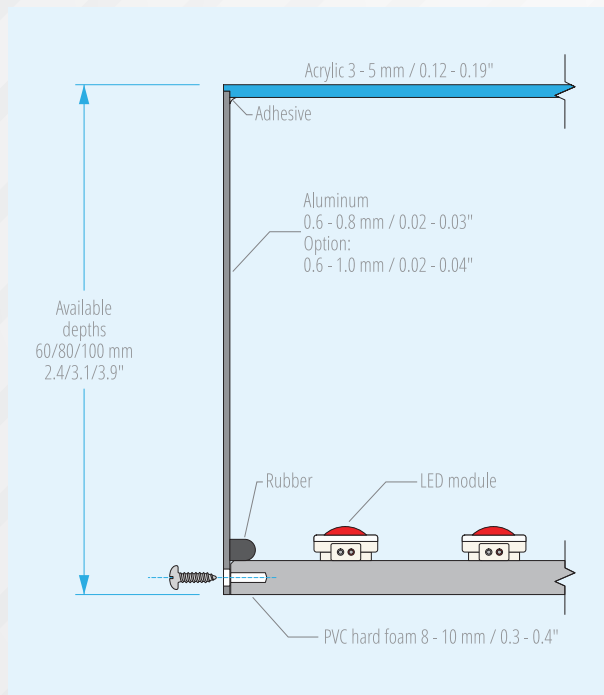
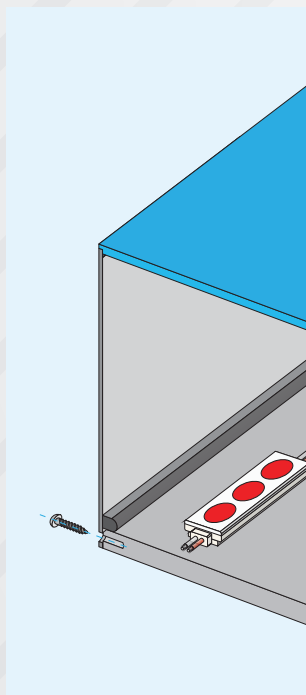

# TrueTrimless™

## Face-lit

- ❖ trim-less acrylic face flush to returns
- ❖ aluminum returns
- ❖ PVC hard foam back
- ❖ paint color matching available
- ❖ reflective white interior

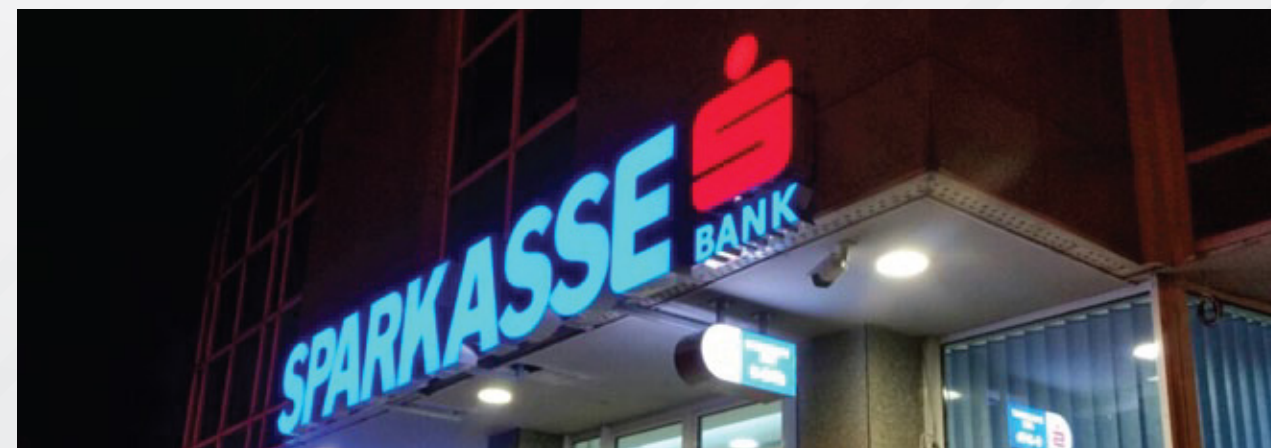
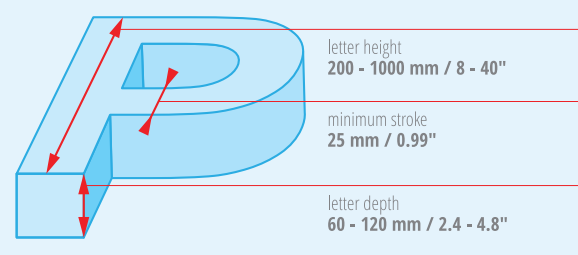



# TrueTrimless™

## Halo-lit

- ❖ halo-lit / partially side-lit
- ❖ powder coated aluminum face and returns
- ❖ paint color matching available
- ❖ reflective white interior

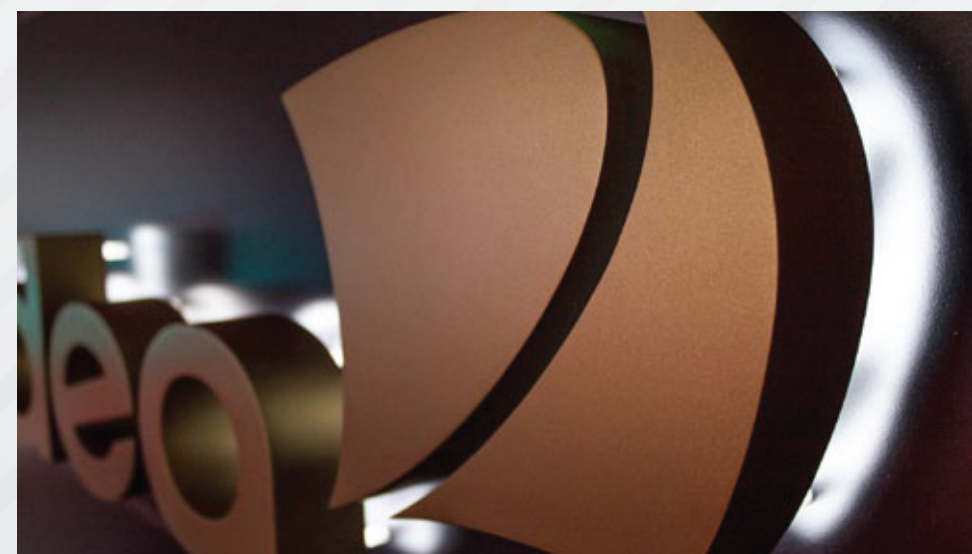
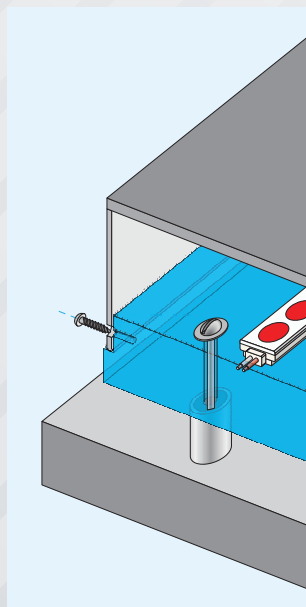
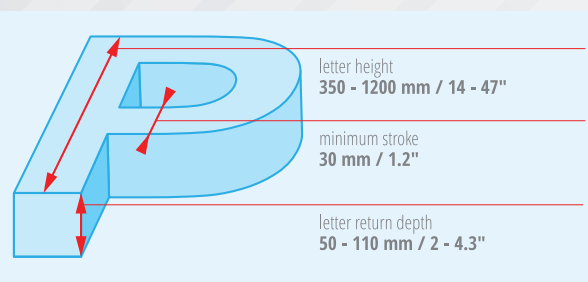
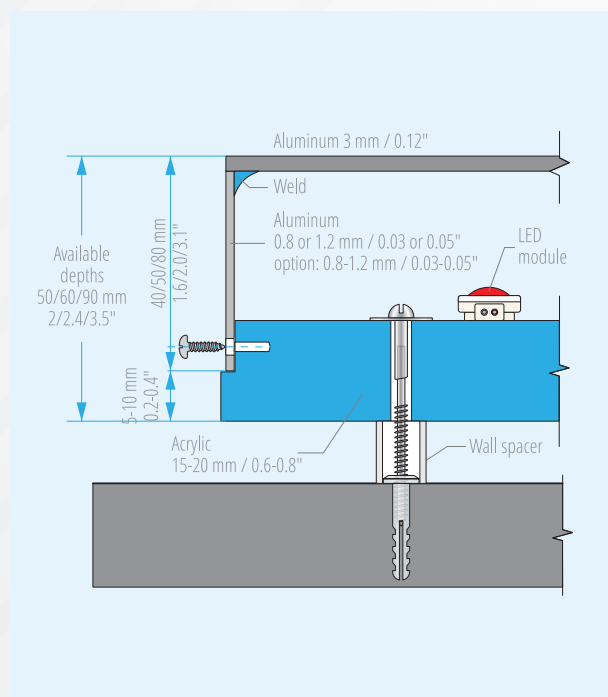



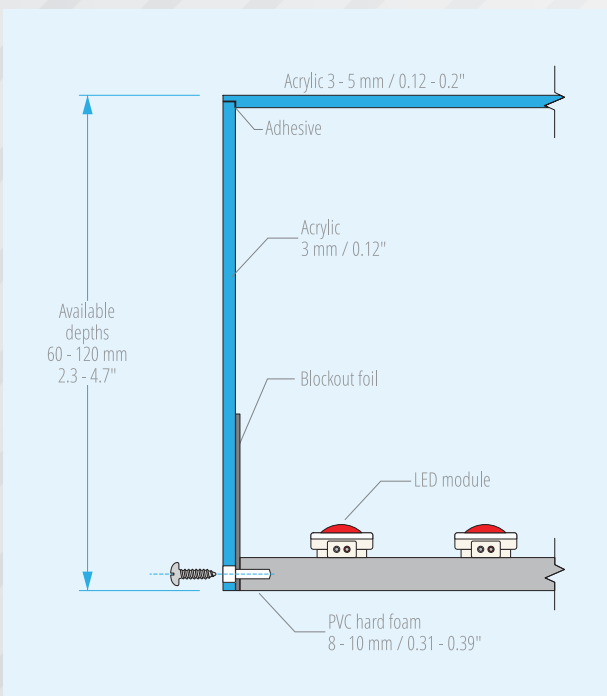

# Brilliance™

- ❖ combination face and side-lit
- ❖ acrylic face and fabricated / formed acrylic returns
- ❖ PVC hard foam back
- ❖ paint color matching available
- ❖ reflective white interior

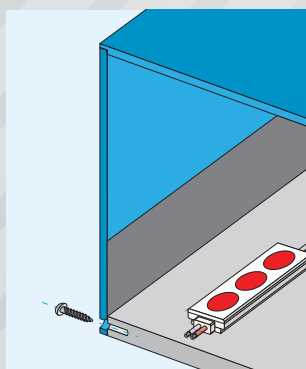
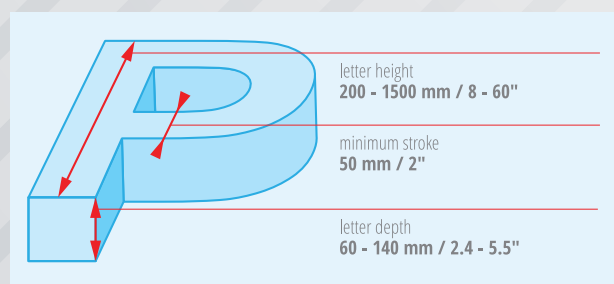

# Creative Illuminated Lettering Solutions

Our specialty is producing custom, low-profile, trim-less illuminated lettering to stretch the possibilities of design.



## 48h Quote Turnaround

Submit your design, and we'll make sure you get a quote within 48 hours. Don't forget to submit your dimensional requirements, illumination specifications, and material preferences.



## 20 Day Delivery

In most cases once you submit your vector artwork, we can manufacture your custom letter forms and deliver to your door within 20 days from art approval.



## 3 Year Warranty

We guarantee our products from manufacturer defect for a period of 3 years from the date of shipment.



# FIREBRAND

John Bailey  
1.843.459.4239  
john@wearefirebrand.com  
[www.wearefirebrand.com](http://www.wearefirebrand.com)